



*Know-how in food processing!*



## Circular Blade Cutting Machines Cortex CB SLICER

Highest throughput and best product appearance

# Highest throughput and

## The principle

The NOCK Cortex CB SLICERS operate with a blade shaft with circular blades. The circular blades dip in the grooves of the counter-roller (intersection roller) which guarantees an excellent intersection of products even with skin or tendons. The product is cut simultaneously and vertically to the transport direction. The NOCK SLICERS are continuously fed with an infeed conveyor. The NOCK CB 435/4E HVC HORIZONTAL-VERTICAL-CUTTER has an additional horizontal cutting unit.

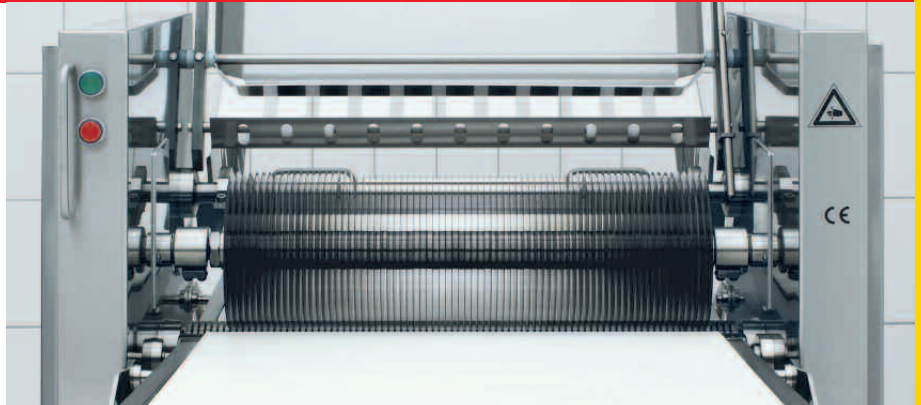

## Various operational fields

The NOCK circular blade cutting machines Cortex CB SLICER are the economic solution when huge quantities of **non frozen and boneless products need to be cut into slices or strips with high cutting quality in a short while.**

The operational fields are really versatile.

### Examples:

- escalopes or steaks from pork, beef or veal
- strips (e.g. from chicken breast)
- meat for Asian dishes
- poultry
- fish fillets or whole fish
- offal (stomach, lung, paunch etc.)
- dicing meat for sausage production

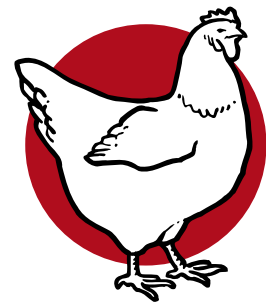
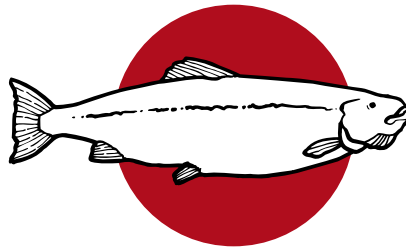
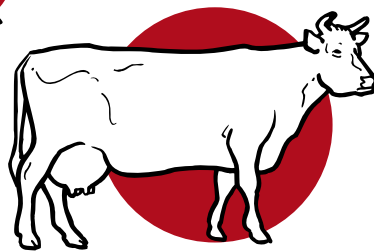
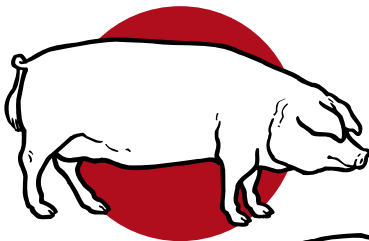

### Tip:

NOCK offers special cutting machines to produce Doner or Gyros slices of meat!

The NOCK SLICERS do not achieve calibrated weight of the single slices but they are efficiently applied for the production of **accurate weight of self service packages with several slices** e.g. steaks.

Diagonal cuts 45° or other angles can be achieved by placing the product diagonally on the infeed conveyor.

### Tip:

You are not sure if your product can be cut with a NOCK CB SLICER with good results? We will test your product without obligation!

The circular blade cutting principle guarantees a **standardized thickness of slices** and **even slices** as the product is not pressed into boxes contrary to its structure.

## Particularly smooth cut

The circular blade cutting principle, the fully developed cutting configuration and proven speed ratios between blade shaft, counter-roller and infeed conveyor ensure a gentle infeed of the product and a **fine, even and particularly smooth cut.**

The product will not be pressed and not be strained by oscillating blades or guillotine knives which operate at high speed, as this is the case with other cutting methods.

Previous **frosting** of the product is **not necessary** to achieve good cutting results with the NOCK SLICERS. This saves energy costs and time. However if the product should be frosted for other reasons it is still no problem to cut it as long as it is not frozen hard.

# best product appearance

## Huge capacity

The infeed conveyor belt of the NOCK SLICER has a continuous speed of **18 m/min**, i.e. the operator can load the belt every minute with 18 m of product to be cut = more than 1 km per hour.

### Practical example for CB 495/5K SLICER:

Pieces of pork neck with an average length (placed crosswise) of 20 cm, placed with a distance of 15 cm = 50 pieces per minute = 3000 pieces per hour. With an average weight of 2.5 kg per piece, 7.5 tons can be processed per hour.

**With the huge capacity of a NOCK SLICER there will be no more bottlenecks when processing.** Only use expensive, relatively slow and meat straining cutting machines for defined weight if it is really necessary. With an additional NOCK circular blade cutting machine you gain more flexibility and expeditious profit.

## Cutting cubes



Cubes e.g. from chicken breast can be cut in a second operation or with two machines standing at a 90° angle. The meat passes automatically onto the second machine and needs no second operator.

## Distances of blades

The minimum distance of blades is 6 - 8 mm, depending on the product. This distance can be changed in multiple to the basic grid of the transport roller, e.g. 8 - 16 - 24 - 32 - 40 mm etc. Common basic grids are 6 - 7 - **8** - 9 - 10 - 11 mm. The blade shaft can be easily changed with the provided lift-out-device in a few minutes.

### Tip:

With blade distances less than 10 mm, the thickness of the slices may be up to 2 mm less than the blade distance itself, depending on the product.

**NEW:** Optional quick change system for intersection roller for easier changing of the basic grid.

## Very easy and quick to clean

The NOCK SLICERS are very quick and easy to clean:

- Machines are equipped with lockable castors and can be easily transported to a cleaning area by one person.
- The conveyors can be removed from the machine within seconds without any tools. The conveyor frames can be folded back so that the belts can easily be removed from the frames.
- The complete inside of the machine can be then cleaned with water from the front and back.
- The large smooth surfaces of the machines are very easy to clean.
- The blade shaft can stay in the machine for cleaning or can be taken out with the provided lift-out-device and cleaned and safely stored in the cleaning wagon (optionally available).

## Blade diameters

The NOCK SLICERS are available with two blade diameters:

- 200 mm – maximum processing height 70 mm
- 300 mm – maximum processing height 120 mm

## Easy handling and ideal operating safety

The NOCK SLICERS can be fed **easily, quickly and safely** with a continuously running infeed conveyor. No complicated and time consuming handling with lids or drawers. The machines do not need electronic programming and can be fed and operated also by unskilled workers.

The **operating safety** is ideal. Thanks to the long NOCK EASY-FLOW® safety covers, the NOCK SLICERS comply to the European safety standard EN ISO 13857. The machine stops immediately if the cover is opened.

Operators as well as their colleagues appreciate the **silent running** of the NOCK SLICERS in the working area.



Cortex CB 495/5K SLICER after removing the conveyors



## Sturdy, durable and service friendly

The NOCK circular blade cutting machines have been built since 1996. From the beginning they have proven their value worldwide in hard industrial production applications.

This trouble-free performance of the NOCK SLICERS results from their clear construction, the highly dimensioned driving elements and the proven execution with the 15 mm thick **NOCK POWER PLATES®** inside the machine casing. They guarantee the constant precision and **service friendliness** of all NOCK machines.

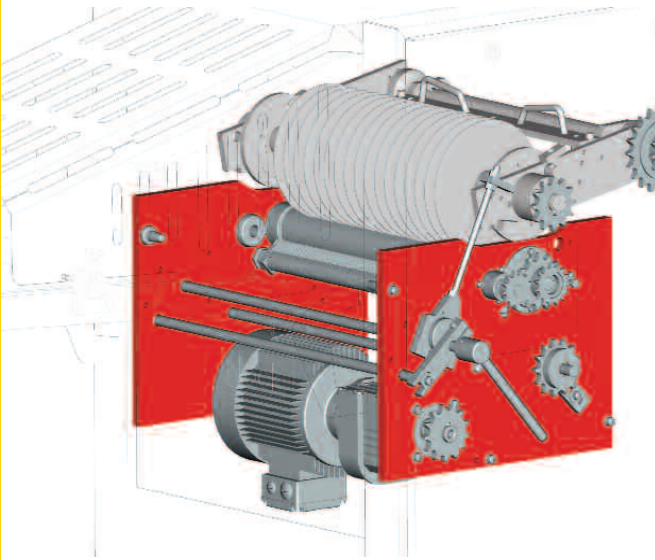

As every blade has to do less cuts, the blades last much longer than with other cutting machines. Depending on the product, ca. 500 - 1000 tons can be cut before the blades must be resharpened.

## Top price-performance-ratio

The NOCK SLICERS do not only convince with an enormous throughput and good cut but also with a **very interesting price**. Request our quotation! You will be positively surprised.

## Recommendable option

**Additional blade shaft for frequently used different blade distance**  
(Photo: with transport- and storage-box, cover removed)

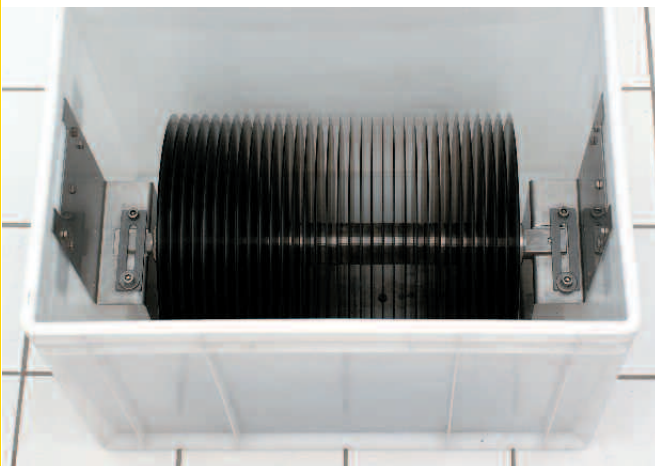

## Uncompromising quality – Made in Germany

NOCK is an owner run German family business, which since 1990 constructs and sells successfully modern machines for the meat processing industry worldwide. In close contact to meat processing plants and distributors, the machines are constantly further developed. Of course the latest hygiene and safety standards are taken into consideration.



*F. Nock*

Ferdinand Nock,  
company founder

NOCK stands for uncompromising quality “Made in Germany”. This begins with the quality-orientated concept and construction of the NOCK machines, comprising of the manufacturing of all central components at the company-own ultra-modern machine park, exclusively using premium base materials and acquired parts, the collaboration with established suppliers, diligent assembling and final inspection of the NOCK machines. An experienced team of highly qualified and motivated employees also contributes significantly to this high quality standard. This results in modern, particularly reliable and durable machines of continuous quality.



NOCK can offer German high class workmanship to interesting prices due to modular construction, modern production methods and strict cost management. This is an important aspect considering the often tightly calculated investment budgets of food processing plants.



## Cortex CB 495/5K SLICER

- Cutting width: 400 mm
- Diameter of blades: 200 / 300 mm
- Cutting speed: 18 m/min
- Output conveyor standard



- The Cortex CB495/5K SLICER 200 with 200 mm blades is the top-selling NOCK circular blade cutting machine with years. The machine is very often used with a blade distance of 12 - 18 mm to **cut huge quantities of escalopes or steaks** where a throughput of more than 5 tons per hour can be achieved. Within minutes it can be re-equipped to **cut strips** with a second blade shaft.
- More operational fields on page 2.
- For cutting chicken breast, it can be equipped with different blade distances on one blade shaft, which allows cutting different widths of strips or cubes without changing the blade shaft.

## Optional for all NOCK SLICERS



Adjustable lateral guides  
at infeed conveyor

Cortex CB 495/5K SLICER 300  
(safety cover open)



## Cortex CB 495/7K SLICER

- Cutting width: 600 mm
- Diameter of blades: 200 / 300 mm
- Cutting speed: 18 m/min
- Output conveyor standard



- The Cortex CB 495/7K SLICER is perfect for **cutting big products in longitudinal direction**, e.g. big pieces of beef, beef paunchs for animal fodder, etc. Or for **cutting long products in lateral direction**, e.g. salmon fillets or whole fish.
- Many machines of this type are already integrated into processing lines in the poultry processing industry.
- It is possible to equip different blade distances in the right/left half of the machine, so in many cases changing the blade shaft is not necessary and allows spontaneous changes of the thickness of the slices, e.g. 16/18 mm.

Optional for all NOCK SLICERS



Cortex CB 495/7K SLICER 200 with 200 mm blades and 8 mm distance of blades; safety cover open



Cleaning wagon for 2 blades shafts  
(cover open, lift-out-device hung in)

## Cortex CB 435/4E COMPACT SLICER

- **Cutting width:** 300 mm
- **Diameter of blades:** 200 mm
- **Cutting speed:** 18 m/min
- Optional: output conveyor with safety cover
- The NOCK COMPACT SLICERS with a 300 mm cutting width and maximum processing height of 70 mm are sufficient for some applications. They are **particularly compact and reasonably-priced**; especially if they are not equipped with an output conveyor.
- Concerning the cutting quality, the COMPACT SLICERS are equal to the K-models.

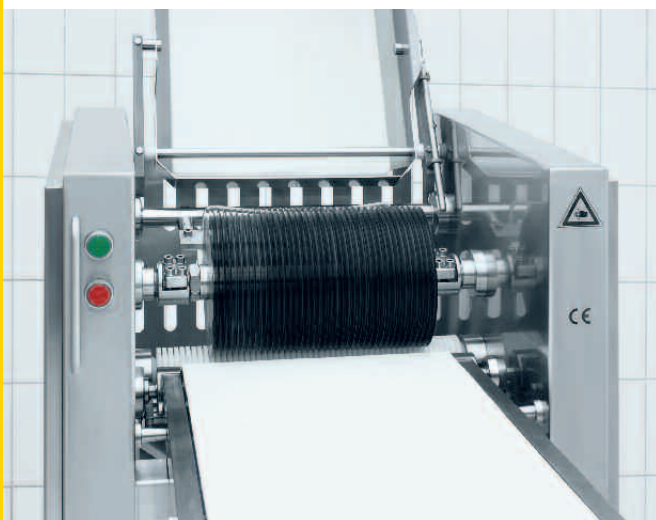

*Safety cover opened, transport roller made of synthetic material with stainless steel core (optional)*

## Cortex CB 435/4E HVC HORIZONTAL-VERTICAL-CUTTER

- **Cutting-machine with band blade for 1 horizontal cut and circular blade cutting unit for vertical cuts**
- For 1 horizontal cut plus many vertical cuts or only 1 horizontal cut or only vertical cuts
- Thickness of the horizontal cut infinitely adjustable from approx 1 mm
- Distance of circular blades adjustable in steps
- Perfect for cutting e.g. chicken breasts, fish fillets etc.
- **Max. throughput height:** 100 mm
- **Operational width:** band blade 370 mm  
circular blade cutting unit 300 mm
- **Conveyor belt speed:** 25 m/min (depending on product)
- Output conveyor: standard



## Technical data / Equipment

	Cortex CB 495/5K SLICER	Cortex CB 495/7K SLICER	Cortex CB 435/4E COMPACT SLICER	Cortex CB 435/4E HVC HORIZONTAL-VERTICAL CUTTER
Direction of cuts	vertical	vertical	vertical	horizontal + vertical
Diameter of circular blades (mm)	200 / 300	200 / 300	200	200
Maximum processing height (mm)	70 / 120	70 / 120	70 (40)	100
Cutting width (processing width) (mm)	400	600	300	370/300
Available circular blade distance grids (mm)	6 - 7 - <b>8</b> - 9 - 10 - 11 <sup>①</sup>			
Quick change system for intersection roller	●	●	●	●
Infeed conveyor (mm)	1170 x 490	1170 x 690	850 x 425	1390 x 425
Output conveyor (mm)	1170 x 490	1170 x 690	○ (650 x 425)	650 x 425
Cutting speed (m/min)	18 <sup>②</sup>	18 <sup>②</sup>	18 <sup>②</sup>	25 <sup>② ⑥</sup>
Adjustable lateral guides at infeed conveyor	○	○	-	-
Electrical consumption (kW)	1.5	1.5	1.1	1.3
Electrical connection	3 AC - 400 V - 50 Hz <sup>③</sup>			
Overall dimension B x H x T (mm)	820 x 1300 x 2450	1020 x 1300 x 2450	700 x 1190 x 1720 <sup>④</sup>	1530 x 1400 x 2420
Weight (kg)	260 <sup>⑤</sup>	320 <sup>⑤</sup>	220 <sup>⑤ ④</sup>	385 <sup>⑤</sup>
Lift-out-device for blade shaft	●	●	●	●
Blade shaft can be adjusted when diameter is decreasing	●	●	-	-
NOCK POWER PLATES®	●	●	●	●
NOCK EASY FLOW® safety cover	●	●	●	●
Lockable castors	●	●	●	●
Stainless steel	●	●	●	●

● **standard**  
○ **optional**

- ① different blade distances in one machine possible
- ② other cutting speeds upon request
- ③ other voltages upon request
- ④ with optional output conveyor
- ⑤ with circular blade distance 8 mm and diameter of blades 200 mm
- ⑥ depending on product

Machines with 900 mm cutting width upon request



**NOCK Maschinenbau GmbH**  
Industriestrasse 14  
77948 Friesenheim  
GERMANY

Tel: +49 (0) 7821-92 38 98-0  
Fax: +49 (0) 7821-92 38 98-18  
E-mail: [info@nock-gmbh.com](mailto:info@nock-gmbh.com)  
[www.nock-gmbh.com](http://www.nock-gmbh.com)